

Multimedia LCD Projector

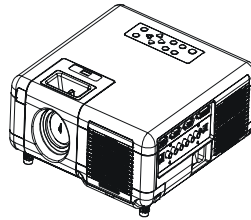

About User's manual Thank you for purchasing the LCD projector. Please read this user's manual thoroughly to ensure correct usage of the projector and its features. After reading, store this instruction manual in a safe place for future reference.

Projector Feature

1. Business/ Home theater projector.
2. Support P-scan / 3:2 pull down
3. Intelligent controlling fan system.
4. Two way keystone function, horizontal & vertical.
5. Auto ceiling function.
6. Still function, digital zoom
7. Slim type remote control.

The content of this manual is subject to change without period notice.

All rights reserved.

Issue of edition 0102.25_04

Table of Contents

- **Safety Instructions**..... 04
- **Checking the Package Content**..... 10
- **Before Use**

Names and Function of Each Part

Main Unit.....	12
Keypad Control	14
Rear View / IO Board	16
Bottom View.....	18
Remote Control.....	19
Inserting the batteries.....	20

Installation

Setting Up the Projector.....	23
Screen Size and Projection Distance.....	25
Adjusting the Image position.....	26
Moving the Projector.....	27

How to connect

Desktop PC.....	28
Laptop PC.....	29
DVI-I port.....	30
USB Mouse.....	31
Video.....	32

Basic Operation

Turning on the Projector.....	34
Adjusting the screen image.....	36
Turning off the power.....	37

Function of Menu(OSD)

Keypad operating.....	38
Computer mode.....	39
Video Mode.....	46

Maintenance and Troubleshooting

Cleaning the Projector.....	52
Cleaning the Lens.....	52
Cleaning the Air filter.....	53
Lamp Replacement.....	54
Indicator.....	55
• List of Monitor Displays Modes	56
• Specification	57

About the symbols

Various symbols are used in this instruction manual and on the product itself to ensure correct usage, to prevent danger to the users and others, and to prevent property damage. The meanings of these symbols are described below. It is important that you read these descriptions thoroughly and fully understand the contents.



Warning

This symbol indicates information that, if ignored, could possibly result in personal injury or even death.



Caution

This symbol indicates information that, if ignored, could result possibly in personal injury or physical damage.

Typical Symbols



This symbol indicates an additional warning (including cautions). An illustration is provided to clarify the contents (for example: the illustration to the left indicates danger of electrical shock)



This symbol indicates a prohibited action. The contents will be clearly indicated in an illustration or description near the symbol (for example: the symbol to the left indicates that disassembly is prohibited)



This symbol indicates a compulsory action. The contents will be clearly indicated in an illustration or description near the symbol (for example: the symbol to the left shows that the power plug should be disconnected from the power outlet).



Warning

■ If a problem should occur.

- If smoke or a strange odors arise, continued use could result in fire or electrical shock. In such case, immediately turn off the power switch and then disconnect the power plug from the power outlet. After making sure that the smoke or odor has stopped, contact your dealer for repairs. Never attempt to make repairs yourself because this is dangerous.
- Do not use this projector if there is no image or sound, or if the sound is distorted. Continued use could result in fire or electrical shock. In such case, immediately turn off the power switch; disconnect the power plug from the power outlet and contact your dealer.
- If water enter the inside of this projector, immediately turn off the power switch, disconnect the power plug from the power outlet and contact your dealer

■ Do not install on an unstable surface.

- Do not install this projector on an unstable surface such as a wobbly stand or incline because this could result in the projector falling and causing injury.

■ Do not open the cabinet.

- Never open the cabinet. There is high voltage inside which can cause electrical shock. Contact your dealer for internal inspection, adjustment and repair.

■ Do not modify.

- Do not modify this projector because this could result in fire or electrical shock.

■ Do not use in the bathroom.



- Do not use this projector in the bathroom because this could result in fire or electrical shock.

■ Do not insert objects into the projector.



- *Do not insert metal objects through the ventilation openings, etc., of this projector or drop such objects inside because this could result in fire or electrical shock.

*** If a foreign object enter this projector, immediately turn off the power switch, disconnect the power plug from the power outlet and contact your dealer.**



- *Continued use could result in fire or electrical shock. Use special caution in households where children are present.





Warning



- **Do not look through the lens when the lamp is on.**
Never look through the lens when the lamp is on. The powerful light could adversely affect vision. Use special caution in households where children are present.
- **Avoid shock or impact on the projector.**
 - If the projector fall, resulting in damage to the cabinet, immediately turn off the power switch, disconnect the power plug from the power outlet and contact your dealer.
 - Continued use could result in fire or electrical shock.
- **Do not place this projector in a container containing liquid. Do not place flower vases, flowerpots, cups, cosmetics, liquids such as water, etc., on top of this projector.**
- **Do not use any power cable except those supplied with the projector.**

 - The use of any other power cable could result in fire or electrical shock.
- **Do not shine the laser beam onto yourself or other**
 - The laser pointer function of projector remote control emits class II laser beam. Do not look directly into the laser beam outlet or direct the laser beam at other people. Vision can be impaired if the laser beam enters the eyes. Especially pay attention if children are present.
- **High temperatures are generated when the lamp is lit; so do not place objects in front of the lens.**



Caution

Placing heavy objects on top of this projector could result in loss of balance or falling and cause personal injury or damage the projector.

- **Do not block the ventilation openings.**
 - **Do not block the ventilation openings of this projector.**
 Blocking ventilation could lead to internal overheating which could result in fire.
- Do not place this projector on its side during use or push it into a small, poorly ventilated location.
 - Do not place this projector on a carpet or bedding or cover it with a tablecloth, etc. Also, when installing this projector, make sure the ventilation openings are at least 30cm(12in)clearance around the projector.
- **Care and maintenance.**For safety purposes, disconnect the power plug from the power outlet before starting the care and maintenance of this projector.
- **Battery usage.**
 - **Replace the batteries with the same type only.** Do not mix old and new batteries ; this could result in fire or personal injury due to battery cracking or leakage.
 - **Make sure the plus and minus terminals are correctly aligned when loading the batteries.** Incorrect loading could result in personal injury or contamination of the surroundings due to battery cracking or leakage.
- **Have the projector interior cleaned regularly. Contact your dealer to arrange for the service.** Accumulations of dust inside the projector can result in fire or malfunction if not cleaned for an extended period.

**Ask your dealer for details about internal cleaning.*



Caution



■ **Avoid installation in humid or dusty locations.**

• **Do not install this projector in a humid or dusty location.**

This could result in fire or electrical shock.

■ **Do not handle the power cord roughly.**

■ **Keep the power cord away from heaters; the heat could melt the power cord and cause fire or electrical shock.**



■ **Do not touch the power plug with wet hands; this could result in electrical shock.**

■ **When disconnecting the power plug, do not pull on the power cord.** This could damage the power cord and cause fire or electrical shock. Always grip the plug when disconnecting.



■ **When the projector is not to be used for an extended period.**

If the projector is not to be used for an extended period because of travel, etc., disconnect the power plug from the power outlet and replace lens cover.

Location of product safety labels

*Safety labels are used on or within the projector to alert you to items or areas requiring your attention.

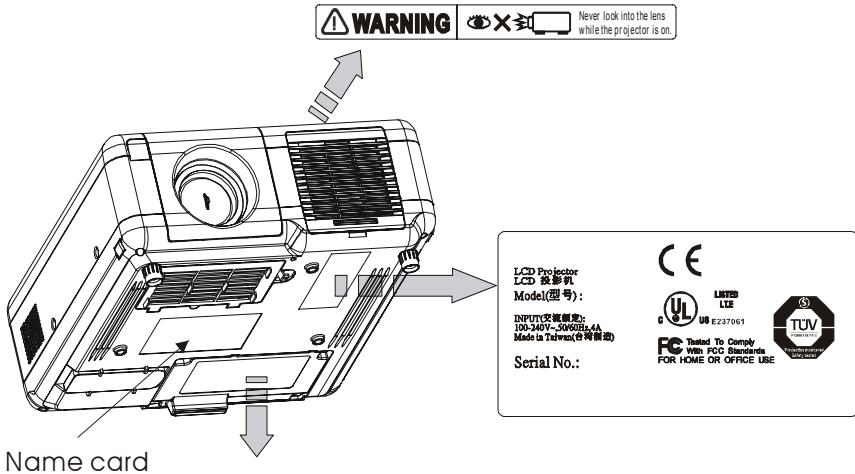

<p>CAUTION Never look into the lens before opening this lamp cover. Ceci s'applique également aux autres appareils qui possèdent un objectif à ouverture de grande profondeur de champ. Évitez de regarder dans l'objectif à l'intérieur de l'appareil.</p> <p>WARNINGS: Never look directly into the lens before opening the lamp cover. This applies to other devices that have a deep depth of field lens. Avoid looking into the lens of the projector.</p> <p>ATTENZIONE: Non guardare mai direttamente nell'obiettivo prima di aprire questo sportello della lampada. La stessa regola si applica anche ad altri apparecchi fotografici con obiettivi a grande apertura.</p> <p>ATTENTION: Nunca mire directamente al lenteo antes de abrir el compartimento de la lámpara. Esto también se aplica a otros aparatos que poseen un objetivo de gran profundidad de campo.</p> <p>PRECAUTIONS: Nunca mire la lenteo directamente antes de abrir el compartimento de la lámpara. Esto también se aplica a otros aparatos que poseen un objetivo de gran profundidad de campo.</p> <p>警告: 請勿直接對準鏡頭或內視鏡蓋未進行換燈動作時切勿自行打開。</p>	<p>CAUTION Never look into the lens before opening the lamp cover.</p> <p>WARNINGS: Never look directly into the lens before opening the lamp cover. This applies to other devices that have a deep depth of field lens. Avoid looking into the lens of the projector.</p> <p>ATTENZIONE: Non guardare mai direttamente nell'obiettivo prima di aprire questo sportello della lampada. La stessa regola si applica anche ad altri apparecchi fotografici con obiettivi a grande apertura.</p> <p>ATTENTION: Nunca mire directamente al lenteo antes de abrir el compartimento de la lámpara. Esto también se aplica a otros aparatos que poseen un objetivo de gran profundidad de campo.</p> <p>PRECAUTIONS: Nunca mire la lenteo directamente antes de abrir el compartimento de la lámpara. Esto también se aplica a otros aparatos que poseen un objetivo de gran profundidad de campo.</p> <p>警告: 請勿直接對準鏡頭或內視鏡蓋未進行換燈動作時切勿自行打開。</p>	<p>CAUTION Never look into the lens before opening the lamp cover.</p> <p>WARNINGS: Never look directly into the lens before opening the lamp cover. This applies to other devices that have a deep depth of field lens. Avoid looking into the lens of the projector.</p> <p>ATTENZIONE: Non guardare mai direttamente nell'obiettivo prima di aprire questo sportello della lampada. La stessa regola si applica anche ad altri apparecchi fotografici con obiettivi a grande apertura.</p> <p>ATTENTION: Nunca mire directamente al lenteo antes de abrir el compartimento de la lámpara. Esto también se aplica a otros aparatos que poseen un objetivo de gran profundidad de campo.</p> <p>PRECAUTIONS: Nunca mire la lenteo directamente antes de abrir el compartimento de la lámpara. Esto también se aplica a otros aparatos que poseen un objetivo de gran profundidad de campo.</p> <p>警告: 請勿直接對準鏡頭或內視鏡蓋未進行換燈動作時切勿自行打開。</p>
--	---	---

Checking the Package Contents

- Projector with Lens cover

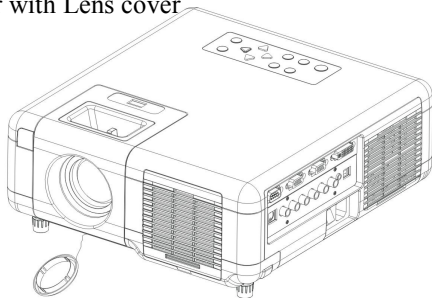

- Remote Control (included battery)



- Power Cord

- S-Video

- Audio/Video Cable

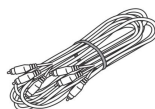
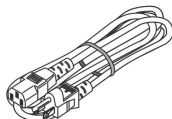

- Computer cable

- Speaker Cable

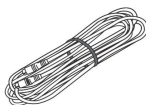
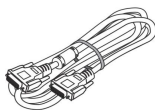

- Filter Sponge

- User's Manual (included CD)

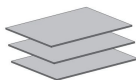

Optional Contents

1. Remote control

(Type 2, with remote mouse
and Laser point function)



2. USB Mouse

(support type 2 remote control)

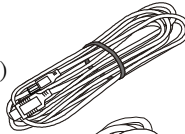

3. DVI Cable

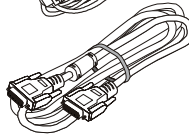

4. RGB -DVI Adapter



5. YPbPr-RGB Cable

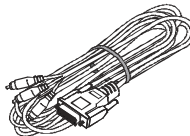

6. Carring Bag

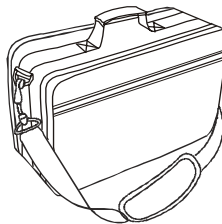

7. Filter Sponge

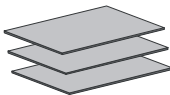

Part Names and Function:

Main Unit

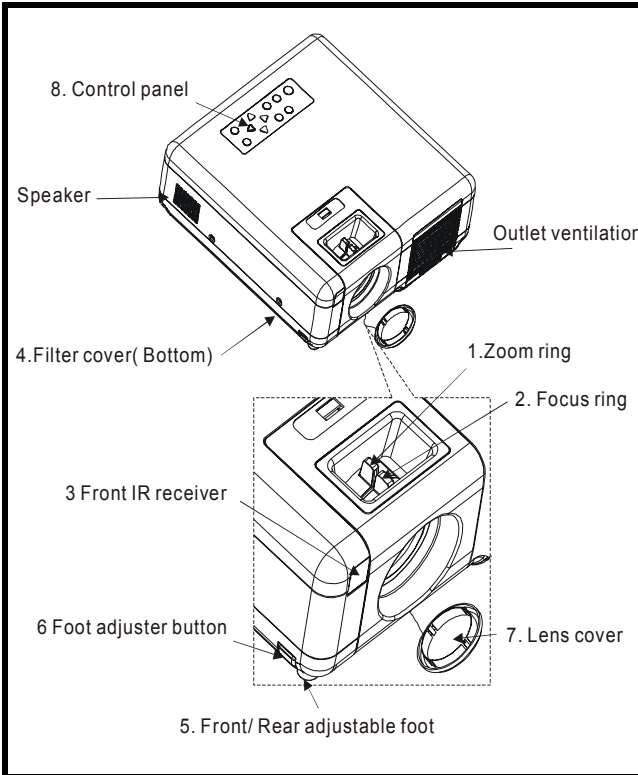

1. Zoom Ring

Use the Zoom Ring to adjust the size of the projected image.

Rotate the Zoom Ring until the image is the desired size.

2. Focus Ring

Use the Focus Ring to focus the projector image.

Rotate the Focus Ring until the image is clear.

3. Front IR receiver

When using the remote control, point the remote control at this sensor..

4. Filter cover

Prevents dust and other foreign particles from being drawn into projector.

Remove the Filter cover to clean the air filter.

5. Front / Rear adjustable foot

Extend and retract to adjust the projection angle

6. Foot adjuster button

Lock/unlock the adjustable foot.

7. Lens cover

Attach when not using to protect the lens from becoming dirty or damaged

8. Control panel (key pads)

Operating system.

Keypad control

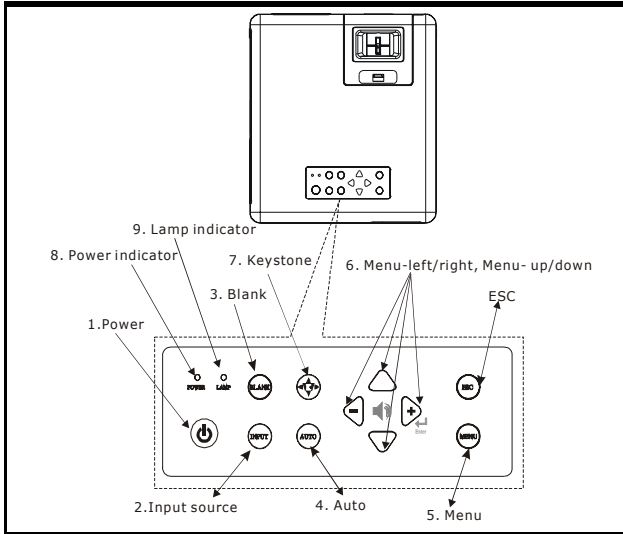

1. Power button

Power on / operation mode, Standby mode, Cooling-down mode

2. INPUT Computer source

Selects between RGB input source-

Computer 1 → Computer 2/RGB or

Computer 2/YPbPr → DVI → AV

→ S-Video → Component Video (YcbCr)

3. Blank

Blanks the projected image. If the projector is left in blank mode for more than 15 minutes, the projector will automatically shut down.

4. Auto

Automatically adjusts the setting to match the current input.

5. Menu

Display or hides the OSD main menu page.

6.Menu-up /down,Menu-right / left

Selecting OSD menu item up or down /

Selecting and adjusting the function of OSD menu item

7. Keystone

Adjusts the vertical keystone with menu-right, menu-left

8.Power indicator

Lights on or flashes to indicate the operating status of the projector.(See Page 56)

9. Lamp indicator

Indicate a problem in the internal projector temperature, lamp cover or cooling down.(See Page 56)

10.ESC

Enters into last status at OSD Menu or hides the OSD Menu

Rear View / IO Board

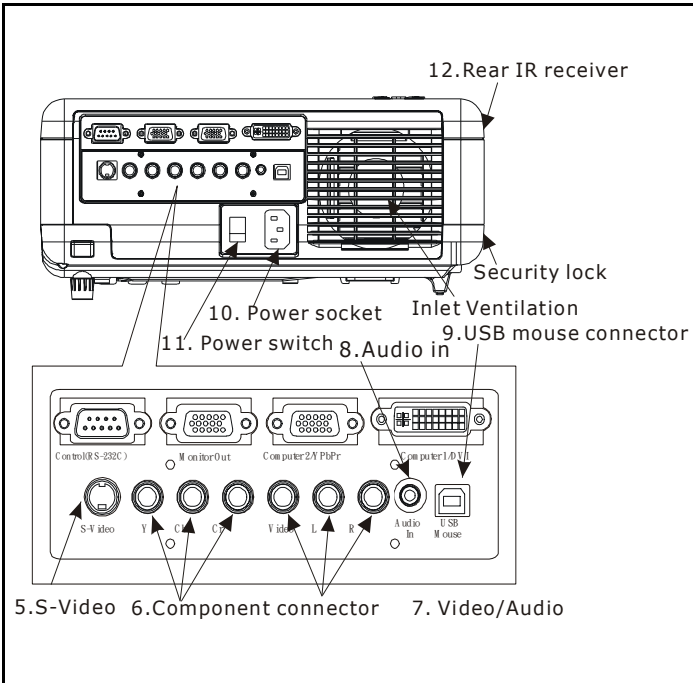

1. Computer1/ DVI connector

Input Analog / Digital RGB video signal from a computer

2. Computer2 / Y Pb Pr (Component video) connector

Analog RGB video signal from a computer or

Component Video (Y,Pb,Pr) signal form the video source .

3. Monitor out connector

Connect an external monitor to this connection view the computer 2 input.

4. Control (RS-232C)

Serial data port for controlling the projector with a computer or other RS-232 control device.

5. S-Video connector

S-Video signal from a video source.

6. Component Video connector (Y,Cb,Cr)

Component video (Y,Cb,Cr) signal from a video source.

7. Audio out connector

Connecting to an external speaker system.

8. Audio in1/DVI

Stereo mini jack for PC input

9. USB mouse connector

Connects a USB mouse cable to a computer to control computer mouse functions.

10. Power socket

Connects the power core to this connection.

11. Power switch

Turns the power on/off.

12. Rear IR receiver

When using the remote control, point the remote control at this sensor.

Bottom View

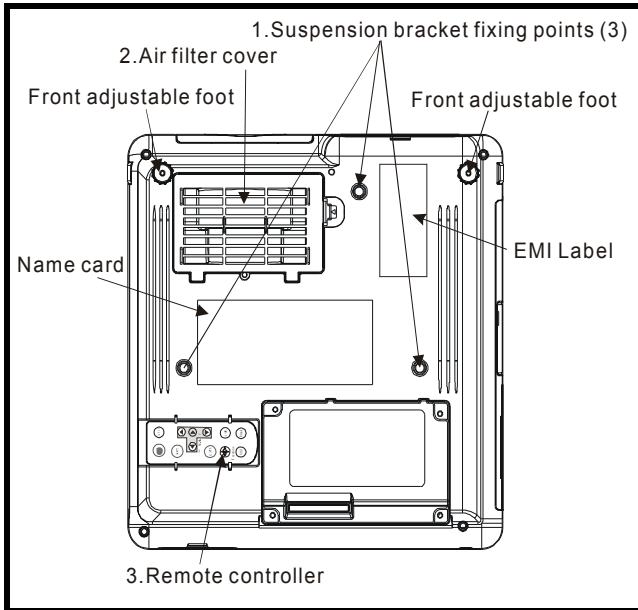

1. Suspension bracket fixing points(3 points)

Install the optional ceiling mount here when suspending the projector from the ceiling.











2. Air filter cover

Prevents dust and other foreign particles from being drawn into the projector.

3. Remote control

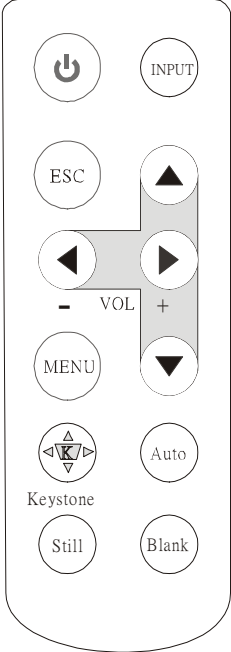
Replace the remote control at the button of the projector.

Remote Control (Type 1)

1.  **Power**
Power on / operation mode, Standby mode, Cooling-down mode
 2.  **Esc**
Enters into last status at OSD menu or hides the OSD menu.
 3.  **Volume up/down**
Sound louder or lower
 4.  **Menu**
Display or hide the OSD main menu page.
 5.  **Keystone**
Adjusts the horizontal and vertical keystone function
 6.  **Still**
Keep the current image on the screen.
 7.  **Blank**
Hide the current image, Become black screen
- 
8.  **Auto**
Refresh the current image.
 9.  **Menu down/Menu up, Menu left/ Menu right**
Selecting and adjusting the function of OSD menu item
 10.  **INPUT source**
Select input source:
Computer 1 → Computer 2/RGB
· Computer 2/YPbPr → DVI → Composite Video → S- Video → Component Video (YCbCr) °

Remote Control Batteries Installation

1. **Remove the battery cover.**
2. **Loading the batteries.**
Make sure the plus and minus poles are correctly oriented.
3. **Close the battery cover.**

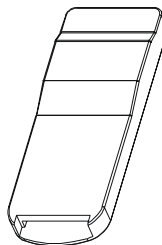

Caution

- *Avoid excessive heat and humidity.*
- *Do not drop the remote control.*
- *Do not expose the remote control to water or moisture, this could result in malfunction.*
- *When the remote control will not be used for an extended period, remove the batteries.*
- *Replace the batteries when remote control operation becomes sluggish or unresponsive.*
- *Do not place the remote control close to the cooling fan of the projector.*
- *Do not disassemble the remote control. If the remote control needs service. Please bring it to the service station.*

Remote Control-Type 2 (optional)

1. Power

Power on / operation mode, Standby mode, Cooling-down mode

2. Laser Pointer

Use laser pointer from remote control.

3. Mouse Left

Mouse left multipurpose key.

4. Mouse Right

Mouse right multipurpose key.

5. Menu

Display or hides the OSD main menu page

6. Menu-up / Menu-down

Selects OSD menu item up or down

7. Menu-right / Menu-left

Selecting and adjusting the function of OSD menu item

8. Keystone up / down

Adjusts the horizontal keystone function.

9. Volume up / down

Sound louder or lower

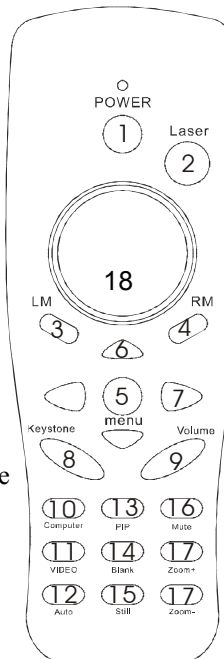

10. Computer source

Selects between RGB input source — computer1, computer2 / RGB, computer2 / Y, Pb, Pr, DVI

11. Video source

Select between Video input source – Composite Video, S-Video, Y Cb Cr Video

12. Auto Sync

Refresh the current image.

13. PIP

Show picture in picture function.

14. Blank

Hide the current image, Become black color on the screen

15. Still

Keep the current image on the screen.

16. Mute

Mute audio

17. Zoom+ / Zoom-

Zoom in or Zoom out

18. Point button

Select an item or adjusts value in the On-Screen Menu.

Remote Control Batteries Installation

Loading AAA batteries into the remote control.

1. Remove the battery cover.

Push the knob while lifting up the battery cover.

2. Loading the batteries.

Make sure the plus and minus poles are correctly oriented.

3. Close the battery cover.

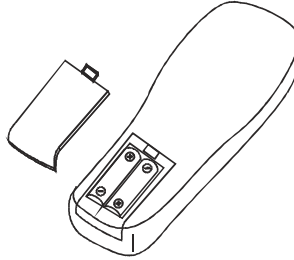

Caution

- Avoid excessive heat and humidity.
- Do not drop the remote control.
- Do not expose the remote control to water or moisture, this could result in malfunction.
- When the remote control will not be used for an extended period, remove the batteries.
- Replace the batteries when remote control operation becomes sluggish or unresponsive.
- Do not place the remote control close to the cooling fan of the projector.
- Do not disassemble the remote control. If the remote control needs service..
Please bring it to the service station.

Warning

The laser pointer function emits a class II laser beam. Do not look directly into the laser beam outlet or point the laser beam at other people. Vision can be impaired by shining the beam into the eyes.

Installation

Setting Up the Projector

The projector supports the following four different projection methods

* Front projection

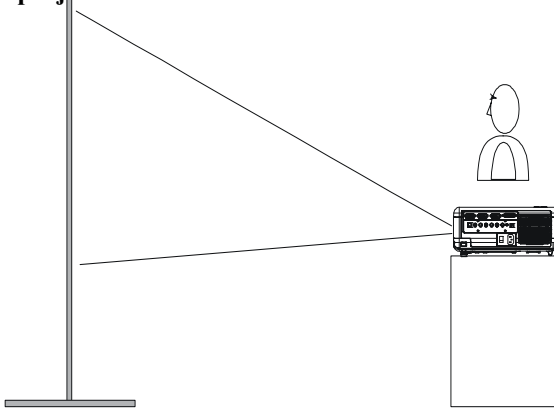

* Rear

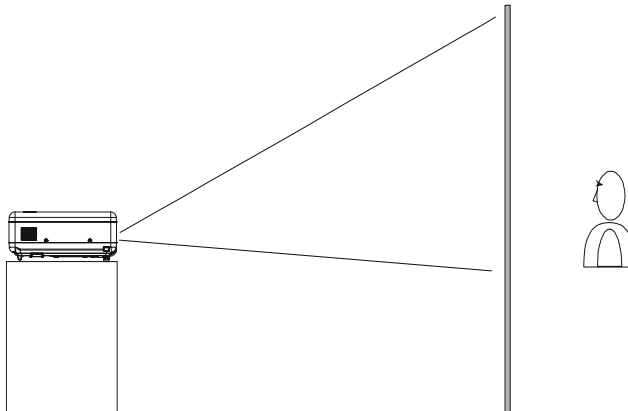

*** Rear ceiling projection**

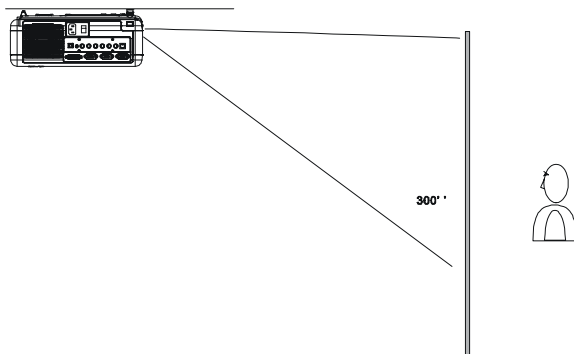

*** Front ceiling projection**

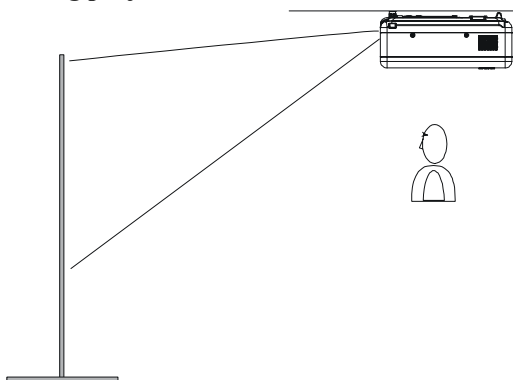

A special method of installation is required in order to suspend the projector from the ceiling. Please ask your dealer for details.

Screen Size and Projection Distance

The distance between the projector and screen determines the actual image size. Refer to the table below to determine the image size at a given distance..

1. XGA F: # 1.75

Image Size(inch)	Distance(M)	
30	1.17	1.40
40	1.55	1.86
50	1.93	2.32
60	2.32	2.77
80	3.08	3.69
100	3.84	4.60
200	7.66	9.17
260	9.94	11.92

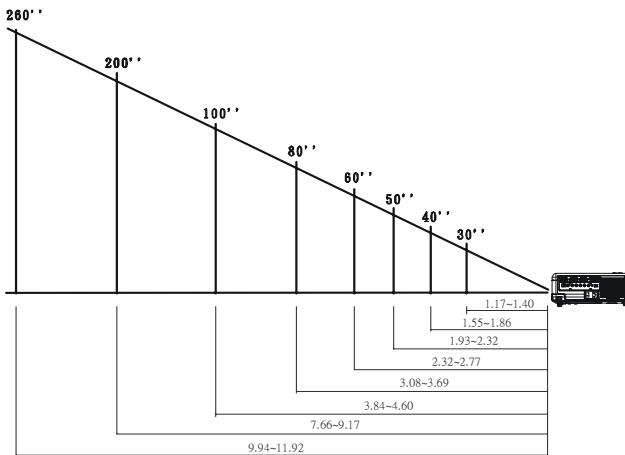

Adjusting the Image Position

Use the adjustable feet at the front of the projector to set the image height. Rotate the adjustable feet at the rear of the projector to fine-tune the image position.

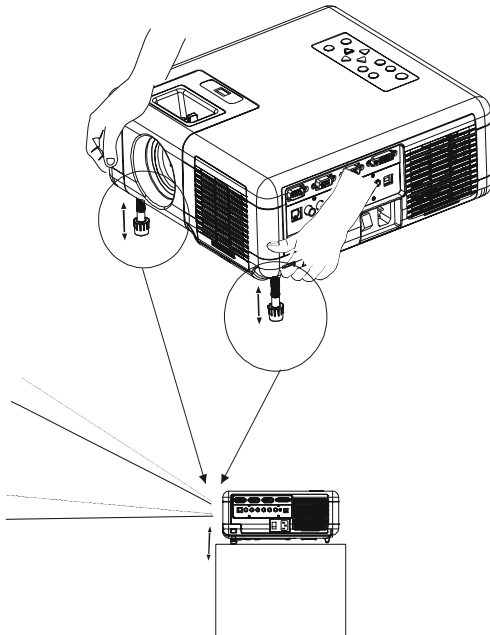

**When the feet are adjusted, it may cause the shape of the projected images to become distorted. Use the keystone correction function to correct this distortion.*

**To retract the front adjustable feet, keep press the feet release button. The front adjustable foot will slowly retract inside the projector.*

Moving the projector

1. Use the carrying bag when moving the projector. (option)
2. Replace the lens cover and retract the front adjustable foot when moving the projector to prevent damage to the projector.

 Caution

The optional carry bag is intended to protect the projector from dust and scratches on the surface of the cabinet. It is not designed to protect the projector from external shock.

Do not transport the projector in an unsuitable transport case by using a courier or transport service. This may cause damage to the projector.

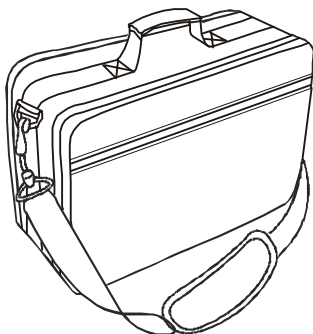

Carrying bag

(Optional, please contact BOXLIGHT for more information)

How to Connect

Desktop PC

Before starting, make sure that the projector and computer are both turned off.

1. Connect the computer cable.
 - 1.1 Connect either end of the computer cable to the projector's computer 2 / Y Pb Pr input port.
 - 1.2 Disconnect the monitor cable from the computer and connect the other end of the terminal where the monitor cable is disconnected from the computer.
 - 1.3 If needed, connect the monitor cable of the computer monitor to the projector's Computer out.
 - 1.4 Tighten the screw on all connectors.

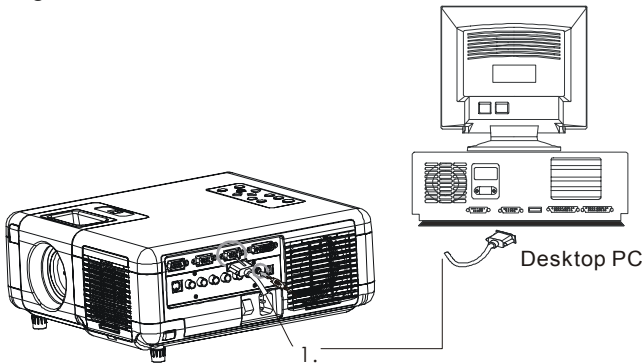

2. Connect the audio cable if necessary.
 - 2.1 Connect one end of the audio cable to the Audio in 2 jack on the projector.
 - 2.2 Connect the other end of the audio cable to the audio output on the computer sound card.

Laptop PC

PC laptop computer

Before beginning, make sure that the projector and laptop are both turned off.

1. Connect the computer cable.
 - 1.1 Connect either end of the computer cable to the projector's computer 2 / Y Pb Pr input port.
 - 1.2 Connect the other end of the project cable to the monitor out connection on the laptop.
 - 1.3 Tighten the screw on all connectors.

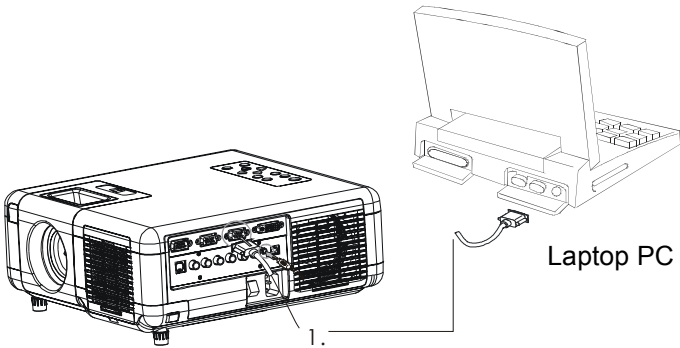

2. Connect the audio cable if necessary.
 - 2.1 Connect one end of the audio cable to the Audio in 2 jack on the projector.
 - 2.2 Connect the other end of the audio cable to the audio output port on the laptop PC.

PC desktop computer (DVI-I port)

before beginning, make sure that the projector and computer are both turned off.

1. Connect the computer DVI cable.(optional)
 - 1.1 Connect either end of the DVI cable to the projector's computer 1 input port.
 - 1.2 Disconnect the monitor cable from the computer and connect the other end of the terminal where the monitor cable is disconnected from the computer.
 - 1.3 Tighten the screw on all connectors.

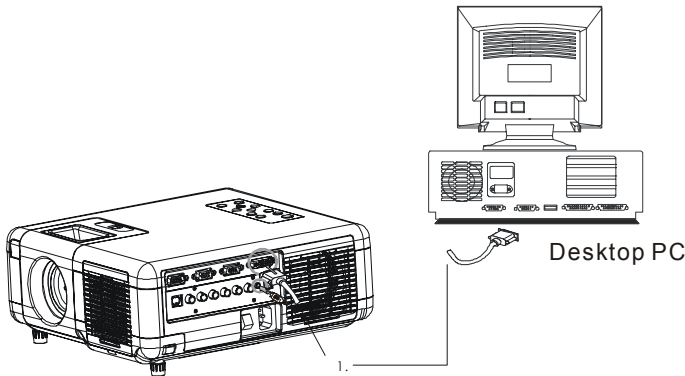

2. Connect the audio cable if necessary.
 - 2.1 Connect one end of the audio cable to the Audio in 1jack on the projector.
 - 2.2 Connect the other end of the audio cable to the audio output port on the computer.

USB Mouse

USB mouse compatible MS-Windows98/2000/NT/XP/Me, Macintosh :OS8.6~10.1, and a Microsoft Mouse driver installed.

1. Insert the end of the USB Cable (B-Type) to the projector's USB port.
2. Connect the end of the USB Cable (A-type) to the computer's USB port.
3. When the projector and computer are turned on, the appropriate drivers should load automatically.

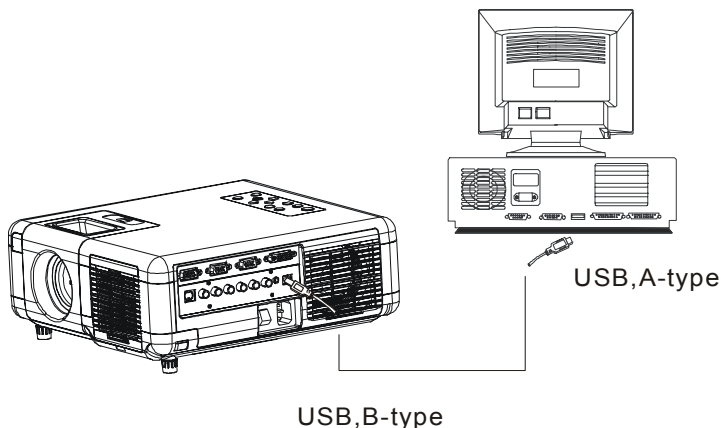

Video

A. Connect to a video source

The Projector can receive composite Video/stereo-audio, S-Video or Component video(YCbCr) signals.

1. The composite video and stereo-audio inputs are yellow, white and red RCA connect on the projector. Connect the yellow RCA plug at one end of the video/stereo-audio cable to the yellow video jack. Connect the other yellow RCA plug to the video-out jack on the video source.

2. The red and White connections are audio connectors. To use the projector speakers connect the audio cable between the projector and the audio source as shown below.

2.1. Insert the white plug into the L-Jack and red plug into the R-Jack.

2.2. Connect the other end of the cable to the output jacks of the audio source.

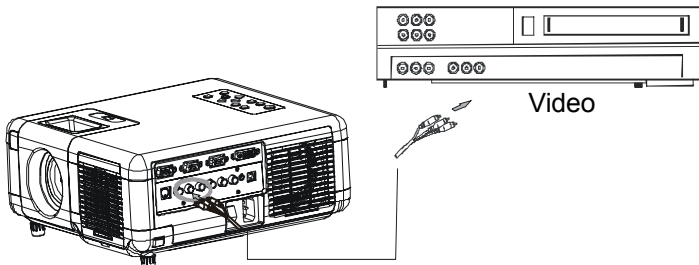

3. For the S-Video, insert one end of the S-Video cable into the projector's S-Video jack. Insert the other one end in the S-Video out jack on your S-Video source.

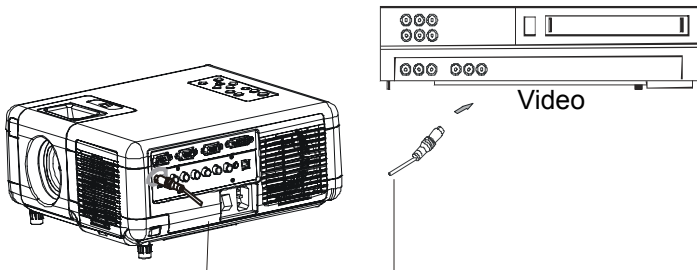

4. For the Component video(Y,Cb,Cr) input uses the green, red, and blue RCA connections on the back of the projector. Connect the green RCA plug at one end of the component video cable to the projector's Y Jack(green color). Connect the blue RCA plug at one end of the component video cable to the projector's Cb jack (blue color). Connect the red RCA plug at one end of the component video cable to the projector's Cr Jack(red color).

Note : When using the S-Video or Y, Cb, Cr input, connect the video/stereo-audio cable to the red and white R and L jack on the projector: Insert the red RCA plug to the right channel and white RCA plug to the left channel.

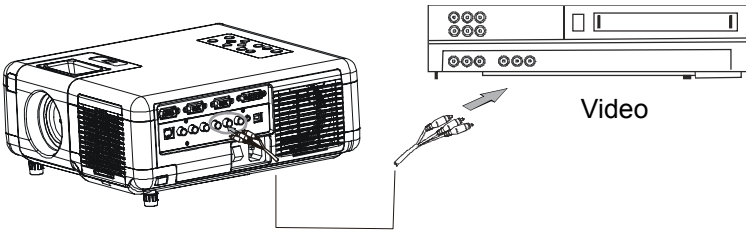

B.Connect to a Component Video(RGB) source

The Projector can receiver Component Video(RGB) signals.

1. Use the optional HD15/component video cable to connect the video source to the Computer 2/ Y,Pb,Pr connector at the rear of the projector.

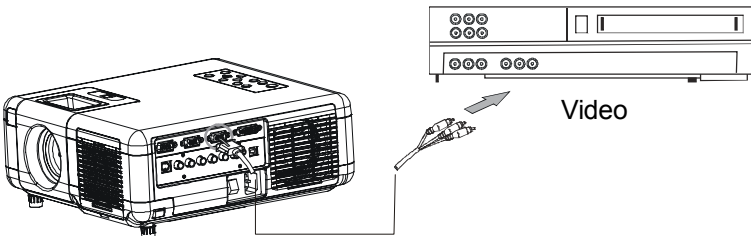

Note : for RGB Video's audio sound, connect the video/stereo-audio cable to the projector's R jack and L jack : insert the red RCA plug to the right channel and white RCA plug to the left channel.

Basic Operation

Turning on the projector

Procedure

1. Check the power is turned off for the projector and all components connected to the projector.
2. Remove the lens cover.
3. Connect the power cord to the projector.
4. Turn on the power switch.
5. Press the  button on the control panel or [POWER] button on the remote control.

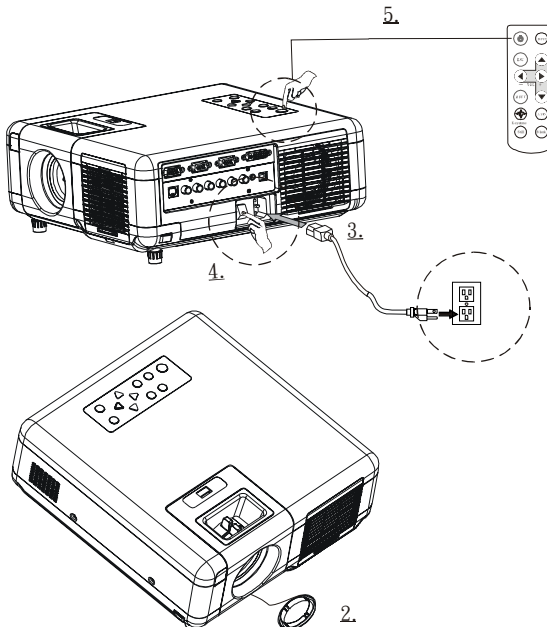

6.The power indicator will flash green .

7.Press the [VIDEO]/[PC] button on the control panel or the Computer/Video buttons on the remote controller to select the appropriate source.

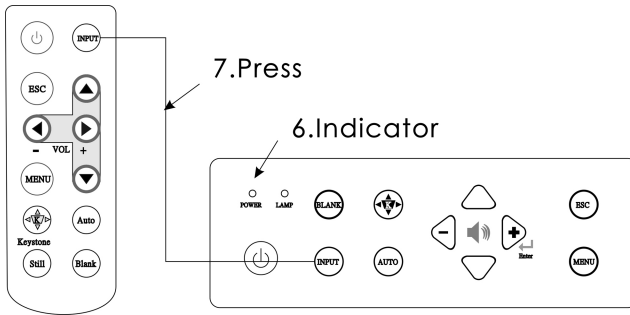

8.Using the zoom ring to adjust the screen size.

9.Using the focus ring to adjust the focus.

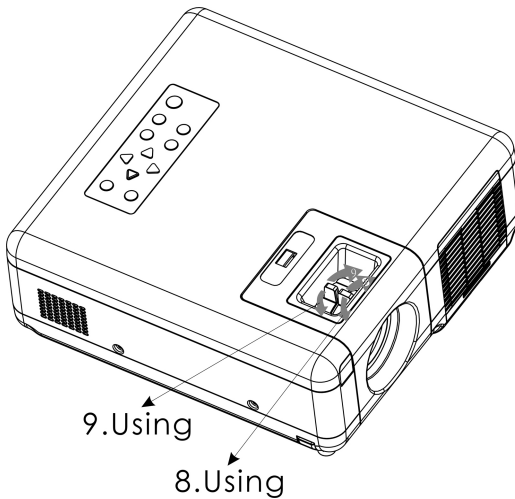

Adjust the Screen Image

1. Adjusting the image size

Turn the zoom ring on the projector to adjust to adjust the image

2. Adjusting the image height.

Extend or retract the front adjustable foot to adjust the height of the image.

3. Correcting Keystone Distortion

Using the [Keystone] button on the projector's control panel.

**Correcting vertical keystone distortion*

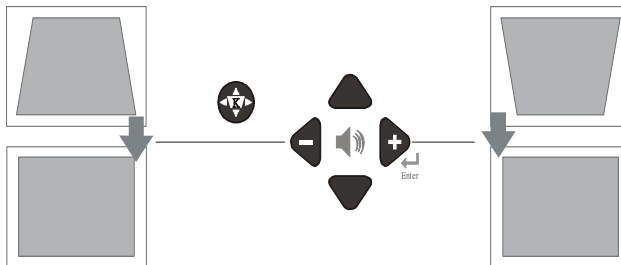

Turning off the projector

1. Press the  button on the projector or remote control. The power off confirmation message appears. If you do not want to power off the projector, ignore the message and it will disappear.



2. Press the power button again and the projector will enter cool-down mode. The lamp shuts off, the lamp indicator flashes red, and the fans continue to run for approximately two minutes. During the cool down sequence the projector will not respond to any control panel or remote control buttons.

Caution: Do not set the power switch to off or unplug the projector during the cool down sequence. Not allowing the lamp to cool properly will greatly reduce the life of the lamp.





3. After the cool-down sequence is complete the fans will shut off and the lamp indicator will stop flashing. The projector is now in standby mode and can be turned back on with the remote control or control panel. If the projector will not be used for an extended period, set the power switch to off and disconnect the power cord.

**The projector will auto turn off when stay in “no signal” status over 15 minutes.

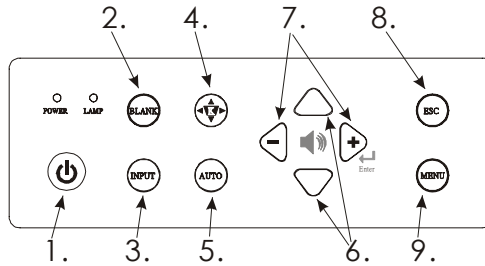
Functions of Menu(OSD)

Keypad Operating:



1.  : Turn on and turn off the projector
2. BLANK : Blanks the projected image. If the projector is left in Blank mode for more than 15 minutes, the projector will automatically shut off the lamp and enter cool-down mode.
3. INPUT : Selects VIDEO or PC input source.
4.  : Adjusts the vertical keystone with the right and left arrow buttons.
5. AUTO : Automatically adjusts the setting to match the current input.
6.  : Up / Down arrow button, used to navigate through the OSD Menus.
7.  : Right / Left arrow button, used to select and adjust OSD Menu functions and Volume
8. ESC: Exit the menu
9. MENU: Enter or exit the main menu (Show and hide the OSD)

*** There is a “ quick Key” on the remote control and projector keypad as well.*

**Press the “ Volume” button on remote control you can adjust value and select between Brightness- Contrast-Keystone-Volume directly. There is the same function for pressing the  button on the keypad.*

PC Mode

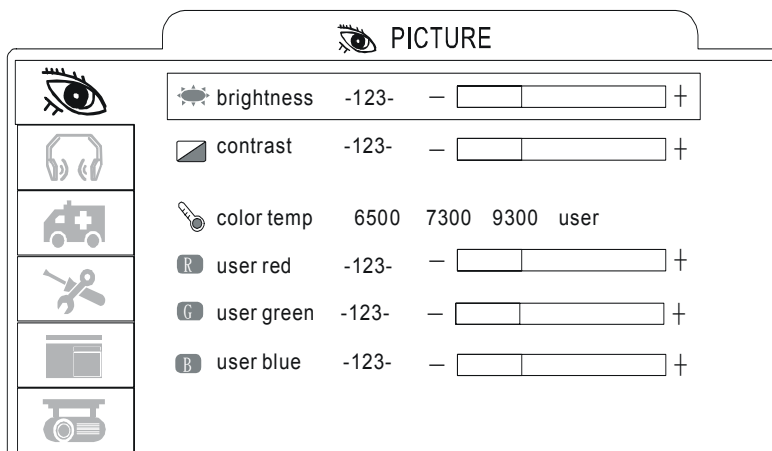

1. PICTURE		
Brightness	-64/+63	Adjusts the overall image brightness
Contrast	-64/+63	Adjusts the difference between light and dark areas of the image
Color Temp		Adjusts the color temperature of the image
	6500K 7300K 9300K User	Sets color temperature to 6500K Sets color temperature to 7300K Sets color temperature to 9300K Enable the separate User color temperature adjustments of each RGB color
	User Red User Green User Blue	-128/+127 -128/+127 -128/+127

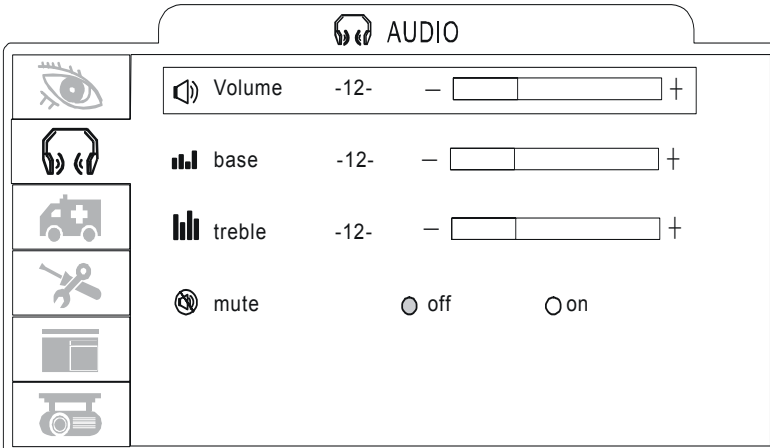



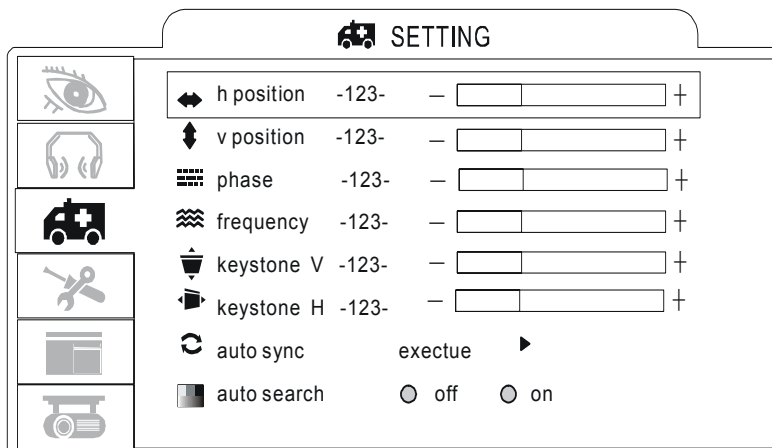











2. AUDIO		
Volume	0/+31	Adjusts the volume
Base	-8/+7	Adjusts the base tone
Treble	-8/+7	Adjusts the treble tone
Mute	On/Off	Mutes the volume on/off





3. SETTING







H position	-128/+127	Move the image position horizontally
V position	-128/+127	Move the image position vertically
Phase	-128/+127	Set the synchronization polarity
Frequency	1294/1394	Set the horizontal scanning frequency
Keystone V	-128/+127	Corrects vertical keystone distortion in image
Keystone H	-128/+127	Corrects horizontal keystone distortion in image
Auto sync	Execute	Sets all of the above setting automatically
Auto search	on/off	Search signal source automatically.

 **ADVANCED**

	zoom/pan		execute	▶
	 still	<input type="radio"/> off	<input type="radio"/> on	
	 blank	<input type="radio"/> off	<input type="radio"/> on	
	 reset all		execute	▶
	 resize		4:3	▶
	 language		English	▶
	 select source		execute	▶
	 Computer 2 Mode		RGB	▶

 **ADVANCED**

 select source

	computer 1	▶
	computer 2(RGB)	▶
	computer2(Y,Pb,Pr)	▶
	DVI	▶
<input type="radio"/>	video	▶
	s-video	▶
	Y Pb Pr	▶

4.ADVANCE		
Zoom/ pan	Execute	Enlarge or reduce the size of the image, pan an image to view images that are larger than the display area
Still	On/off	Freezes the current image on the screen
Blank	On/off	Hides the image, displays a blank, black screen*(see below)
Reset all	Execute	Resets all OSD Menu functions to their factory default values*(see below)
Language	Eng	Select the language that the OSD Menu and on screen message are displayed in English/ Chinese(s)/ Chinese(t)/ Italian / Spanish/ French /German
Select source		Select the input source from: Computer1 / Computer2(RGB) / Computer2 (Y,Pb,Pr)/ DVI / video / s-video / Y,Cb,Cr
Computer2 mode	RGB/Y,- Pb,Pr	Switches computer2 input: RGB / Y,Pb,Pr

***Blank on**

If the projector is left in Blank mode for more than 15 minutes, the projector will automatically shut off the lamp and enter cool-down mode.

***Reset all**

1. After you press [reset all] of the OSD menu, the following confirmation message will appear on the screen.

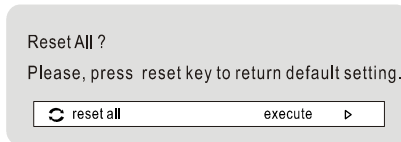

2. Please press the Menu-right button on the remote control or  button on the keypad to reset the OSDMenu values. Please ignore the message to exit the message without changing any setting.

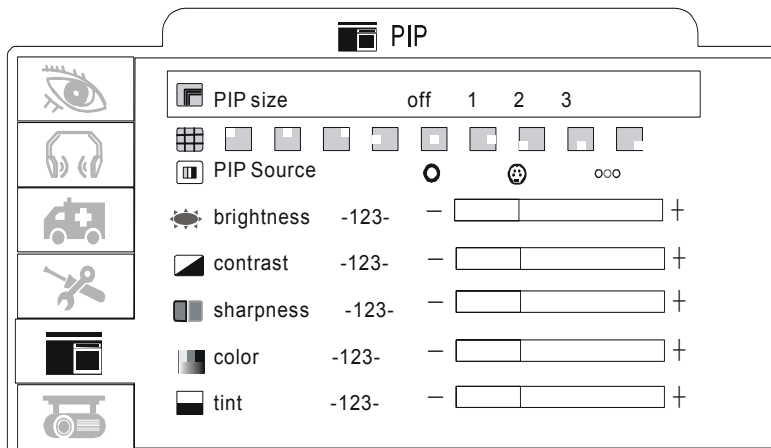

5. PIP		
PIP size	Off 123	Sets the PIP image size
PIP Position	9-position	Moves the PIP image position
PIP source	AV,S,YPbPr	Selects the PIP input source
PIP brightness	-64/+63	Adjusts the brightness of the PIP image
PIP contract	-64/+63	Adjusts the difference between light and dark areas of PIP image
PIP sharpness	-128/+127	Adjusts the image sharpness of the PIP image
PIP color	-128/+127	Adjusts the color intensity of PIP image
PIP tint	-128/+127	Adjusts the tint of the PIP image

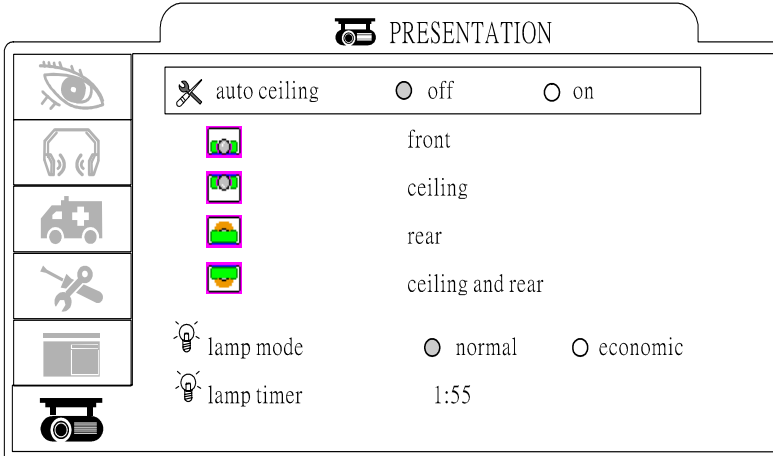

6. PRESENTATION		
Auto ceiling	On/off Automatically	Automatically inverts the image when the projector is turned upside down i.e. when the projector is mounted on the ceiling
Front	Execute	Normal projection mode
Ceiling	Execute	Inverts the image vertically, used when the projector is mounted upside down
Rear	Excute	Inverts the image horizontally, used when projecting onto a rear projection screen
Celing and Rear	Excute	Inverts the image horizontally and vertically, used when the projector is mounted upside down and projecting onto a rear projection screen
Lamp mode	Normal Economic	Economic mode reduces the lamp brightness economic to extend lamp life and quiet the projector
Lamp timer		Lamp timer

Video Mode

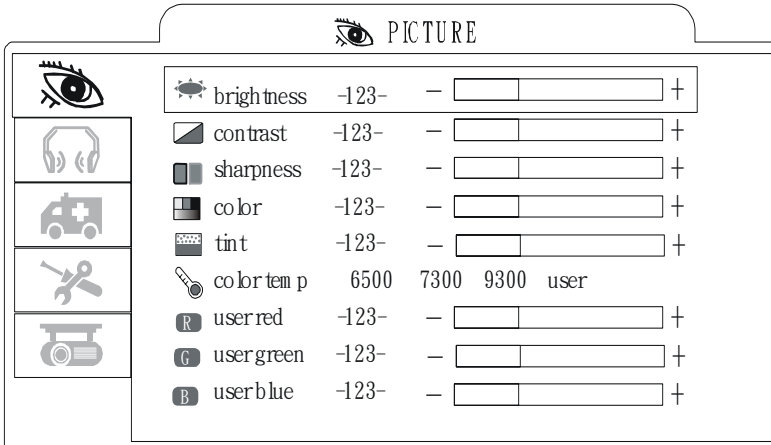

1. PICTURE		
Brightness	-64/+63	Adjusts the overall image brightness
Contrast	-64/+63	Adjusts the difference between light and dark areas of the image
Sharpness	-128/+127	Adjusts the image sharpness
Color	-64/+63	Adjusts the image color
Tint	-64/+63	Adjusts the image tint
Color Temp		Adjusts the color temperature of the image
	6500K 7300K 9300K User	Sets color temperature to 6500K Sets color temperature 7300K Sets color temperature 9300K Enable the separate User color temperature adjustments of each RGB color
	User Red User Green User Blue	-128/+127 -128/+127 -128/+127

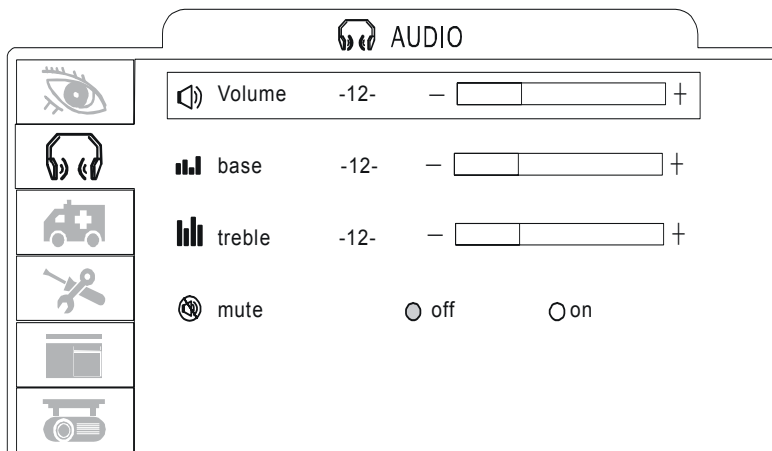





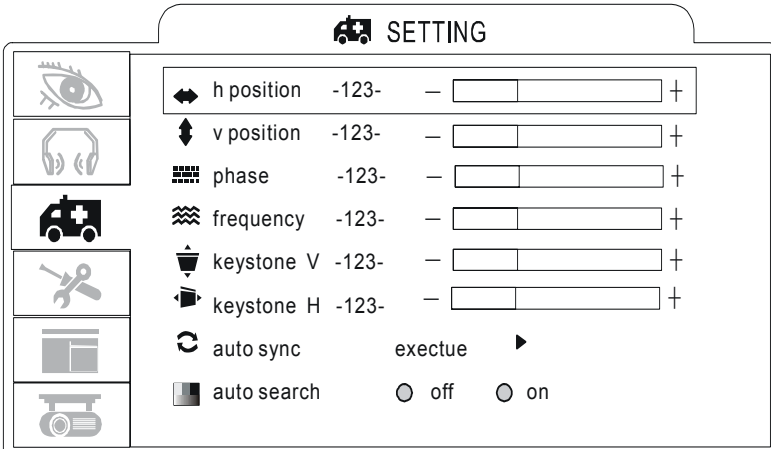











2. AUDIO

Volume	0/+31	Adjusts the volume
Base	-8/+7	Adjusts the base tone
Treble	-8/+7	Adjusts the treble tone
Mute	On/Off	Mutes the volume on/off











3. SETTING		
H position	-128/+127	Move the image position horizontally
V position	-128/+127	Move the image position vertically
Phase	-128/+127	Set the synchronization polarity
Frequency	1294/1394	Set the horizontal scanning frequency
Keystone V	-128/+127	Corrects vertical keystone distortion in image
Keystone H	-128/+127	Corrects horizontal keystone distortion in image
Auto sync	Execute	Sets all of the above setting automatically
Auto search	on/off	Search signal source automatically.

 **ADVANCED**

	 zoom/pan	execute	▶
	 still	<input type="radio"/> off	<input type="radio"/> on
	 blank	<input type="radio"/> off	<input type="radio"/> on
	 reset all	execute	▶
	 resize	4:3	▶
	 language	English	▶
	 select source	execute	▶
	 Computer 2 Mode	RGB	▶

 **ADVANCED**

 select source

	computer 1	▶
	computer 2(RGB)	▶
	computer2(Y,Pb,Pr)	▶
	DVI	▶
	video	▶
	s-video	▶
	Y Pb Pr	▶

4.ADVANCE		
Zoom/ pan	Execute	Temporarily enlarge a portion of the image and view portions of the image that are not visible in the display area.
Still	On/off	Freezes the current image on the screen
Blank	On/off	Hides the image, displays a blank, black screen*(see below)
Reset all	Execute	Resets all OSD Menu functions to their factory default values*(see below)
Language	Eng	Select the language that the OSD Menu and on screen message are displayed in English/ Chinese(s)/ Chinese(t)/ Italian / Spanish/ French /German
Select source		Select the input source from: Computer1/ Computer2(RGB) / Computer2 (Y,Pb,Pr)/ DVI / video / s-video / Y,Cb,Cr
Computer2 mode	RGB/Y,Pb,-Pr	Switches computer2 input: RGB / Y,Pb,Pr

*Blank on

If the projector is left in Blank mode for more than 15 minutes, the projector will automatically shut off the lamp and enter cool-down mode.

*Reset all

1. After you press [reset all] of the OSD menu, the following confirmation message will appear on the screen.

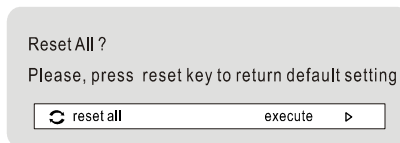

2. Please press the Menu-right button on the remote control or  button on the keypad to reset the OSDMenu values. Please ignore the message to exit the message without changing any setting.

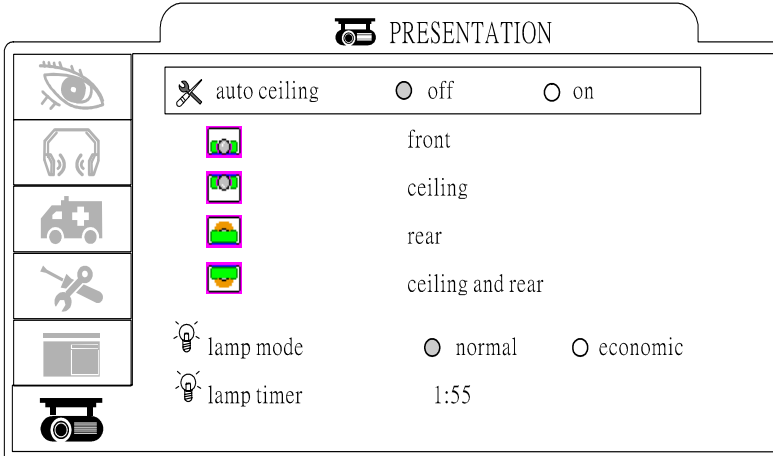

6. PRESENTATION		
Auto ceiling	On/off Automatically	Automatically inverts the image when the projector is turned upside down i.e. when the projector is mounted on the ceiling
Front	Execute	Normal projection mode
Ceiling	Execute	Inverts the image vertically, used when the projector is mounted upside down
Rear	Execute	Inverts the image horizontally, used when projecting onto a rear projection screen
Ceiling and Rear	Execute	Inverts the image horizontally and vertically, used when the projector is mounted upside down and projecting onto a rear projection screen
Lamp mode	Normal Economic	Economic mode reduces the lamp brightness economic to extend lamp life and quiet the projector
Lamp timer		Lamp timer

Maintenance and Troubleshooting

Cleaning the projector

Warning: Always unplug the projector before performing any maintenance.

Clean the projector case by wiping it gently with a soft cloth.

If necessary, the case can be cleaned using a neutral detergent and a soft cloth ensure the case is complete dry before turning the projector back on.

Cleaning the lens

Use a commercially-available air blower, or use a lens cleaning paper and lens cleaner approved for use on optical coatings.

Do not clean the lens with harsh materials or subject the lens to shock, as it can easily become damaged. Close the lens cover when the projector not in use.

Cleaning the Air Filter

A. When the air filter becomes clogged with dust, etc., the projector power may overheat and turn itself off to prevent internal damage. When cleaning the filter, stand the projector up on its side to prevent dust from entering the projector. Use a vacuum to remove the dust from the outside of the air filter. Do not operate the projector with the air filter removed.

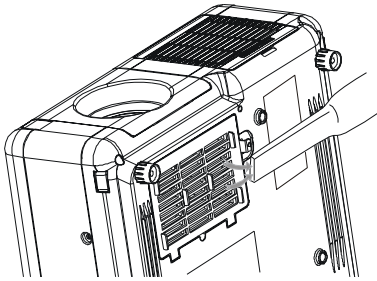

B. Clean the air filter every 100- hours .

**If the filter difficult to clean or if it is deteriorating, it should be replaced*

1. Remove the filter cover on the bottom of projector.
2. Pull out the air filter.
3. Installing the new air filter.

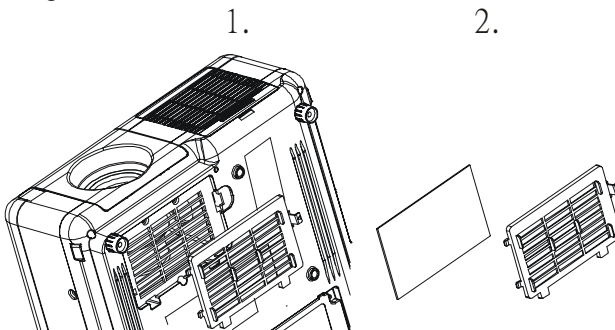

Lamp Replacement

When the life of the projector lamp of this projector draws to an end, the projector would give a signal to remind you to replace the lamp with a new one promptly. In order to maintain the lamp work efficiently

 *Caution: Need to cool-down the projector at least 15 minutes before you open the lamp cover. And make sure the projector is switched off.*

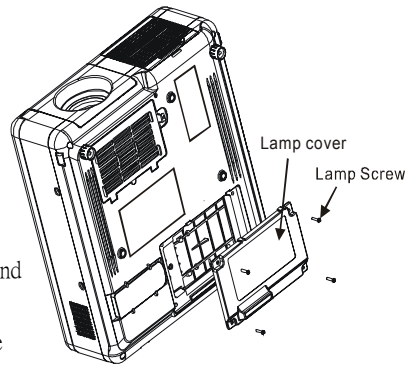

Follow these steps to replace the lamp.

1. Turn over the projector. Loosen the screw and remove the lamp cover.
2. Loosen 2 screw of the lamp and pull out the lamp.
3. Replace the lamp with a new one and tighten the 2 screws back into position. Make sure that the lamp is set properly. Replace the lamp cover and tighten the screw.







 *Caution: Do not drop a lamp or touch a glass bulb! The glass can shatter and may cause injury.*

Note: 1. If the customer open the lamp cover when the projector is on, the lamp will switch off automatically.

2. *If the customer replace the new lamp incorrectly, the lamp would not work properly.*

Indicators

The Power and lamp indicators show the status of the projector. Before requesting repair, check the projector status using the chart below. If the problem cannot be resolved contact your dealer

Power (Green)	Lamp(Red)	Conditions	SignalNotes
Slow flashing 	Off ●	Stand by mode	* Projector is ready to be turned on (normal)
On ●	Off ●	On mode	*Projector is on and operating normally
On ●	Slow flashing 	Cool-down mode	*Projector is in cool-down mode and will not respond to user input (normal)
On ●	Fast flashing 	Fan-fault mode	* The projector has detected a problem with an internal fan, the lamp will shut off automatically, contact your dealer.
Fast flashing 	On ●	Lamp-cover open	*The lamp cover is open or there is a problem with the lamp. If the lamp door is closed and replacing the lamp dose not correct the issue, contact your dealer
Fast flashing 	Fast flashing 	High temperature	*The projector has overheated and shut the lamp off. Correct the over temp condition immediately. 1. Check that the ventilation slots are free from obstructions. 2. If the condition persists, contact your dealer. 3. Check the cleanliness of the air filter.

Symptom	Possible cause	Remedy
The power is not turned on	*The main power switch is not turned on. *The power cord is disconnected.	*Turn on the main power switch. *Plug the power cord into an AC power outlet.
No Video or audio	*The input is not correctly connected. *No signal input	*Select the appropriate input source *Connect correctly
No audio	*The projector is not correctly connected. *The volume is set to minimum. *Mute is turned on	*Connect correctly. *Press VOLUME+ on the remote control or display the menu screen and adjust the volume. *Press theMUTE button.
No image	*The projector is not correctly connected.	* Connect correctly
Image are dark	*Brightness and contrast are not correctly adjusted. *The lamp is nearing the end of its service life	*Adjust the setting of Computer mode in the OSDMenu. *Replace with a new lamp.
Video is burned	*Focus orRGB phase is out of adjustment	*Adjust the focus phase.

List of Supported Monitor Displays

Signal	Refresh Rate (Hz)	Resolution
VGA	70	640X350
VGA	60	640X480
VGACGA	60	640X400
VGA text		720X400
VESA		720X350
VESA	60/72/75/85	640X480
SVGA	56/60/72/75/85	800X600
XGA	60/70/75/85	1024X768
SXGA	60/70/75	1280X1024
TV(480i),NTSC	60	
TV(575i),PAL	50	
SDTV(480p)	60	
HDTV(720p)	60	1280X720
HDTV(1080i)	30	1920x1080
Mac13	67	640X480
Mac16	75	832X824
Mac19	75	1024X768

Specification

Projection Display	Epson0.7" Poly Silicon TFT LCDx3
Resolution	True XGA, 1024x768
Projection Lens	Manual,F#1.75~2.10,f=26.7~32.0mm
Image Size	30"~260"
Projection distance	1.25~8.8m(4.1~28.9')
Uniformity	Typical 85% image center-to-corner
Color Temperature	6400 K~ 6800K
Scanning Frequency	Horizontal at 15~100kHz, V-syns.43~120Hz
Video Compatibility	NTSC,PAL,SECAM,HDTV 1080i/720P/480P
Computer Compatibility	SXGA,XGA,VGA,MAC
Inputs/Outputs	Computer: x1 DVI Computer : x1 Mini D-sub 15pin Monitor out: x1 Mini D-sub 15pin Audio in 1 : x1 mini jack Control(RS-232) S-Video : x1 Mini DN 4pin Video: x1 RCA pin Jack Mouse: x1 USB connector(B-type) Component x1 RCA pin jack
Power Consumption	270Watts / 250Watts
Power Supply	350W fully range from 100V~240V 50/60Hz
Installation	Front/Rear/Ceiling
Dimension(WxHxD)	278x104x294mm
Weight	3.2kg
Operation Temperature	+5~+35 degree
Storage Temperature	-10~+60 degree
Operation Humidity	20~80%RH
Digital Keystone Correction	+/-15 degree(H/V)
Aspect Ratio	4:3 (support16:9)

LIMITED WARRANTY

Boxlight (“Boxlight”) warrants that each CP-740e or CP-730e (“the Product”) sold hereunder will conform to and function in accordance with the written specifications of Boxlight. Said limited warranty shall apply only to the first person or entity that purchases the Product for personal or business use and not for the purpose of distribution or resale. Said warranty shall continue for a period of two (2) years from the date of such purchase. The standard limited warranty excludes the lamps in projectors after 120 days or 500 hours (whichever comes first) and the accessories after one year.

Boxlight does not warrant that the Product will meet the specific requirements of the first person or entity that purchases the Product for personal or business use.

Boxlight’s liability for the breach of the foregoing limited warranty is limited to the repair or replacement of the Product or refund of the purchase price of the Product, at Boxlight’s sole option. Replacement Product may be re-furbished in “like-new” condition, at Boxlight’s sole discretion. To exercise the Purchaser’s rights under the foregoing warranty, the Product must be returned at the Purchaser’s sole cost and expense, to Boxlight or to any authorized Boxlight service center provided, and the Product must be accompanied by a written letter explaining the problem and which includes (i) proof of date of purchase; (ii) the dealer’s name; and (iii) the model and serial number of the Product. When sending your unit in for repair, please ship your unit in its original packing material or a Boxlight approved ATA Shipping Case, or have a professional packaging company pack the unit. Please insure your shipment for its full value. **A return authorization number, issued by the Boxlight customer service department, must also be clearly displayed on the outside of the shipping carton containing the Product.**

WARRANTY LIMITATION AND EXCLUSION

Boxlight shall have no further obligation under the foregoing limited warranty if the Product has been damaged due to abuse, misuse, neglect, accident, unusual physical or electrical stress (unusual physical and electrical stress includes unusually long operation, exposure to smoke and other airborne contaminants), unauthorized modifications, tampering, alterations, or service other than by Boxlight or its authorized agents, causes other than from ordinary use or failure to properly use the Product in the application for which said Product is intended.

DISCLAIMER OF UNSTATED WARRANTIES

THE WARRANTY PRINTED ABOVE IS THE ONLY WARRANTY APPLICABLE TO THIS PURCHASE. ALL OTHER WARRANTIES, EXPRESS OR IMPLIED, INCLUDING, BUT NOT LIMITED TO, THE IMPLIED WARRANTIES OF MERCHANTABILITY AND FITNESS FOR A PARTICULAR PURPOSE ARE DISCLAIMED. THERE ARE NO WARRANTIES THAT EXTEND BEYOND THE FACE HEREOF AND THE FOREGOING WARRANTY SHALL NOT BE EXTENDED, ALTERED OR VARIED EXCEPT BY WRITTEN INSTRUMENT SIGNED BY BOXLIGHT. SOME STATES DO NOT ALLOW LIMITATIONS ON HOW LONG AN IMPLIED WARRANTY MAY LAST, SO SUCH LIMITATIONS MAY NOT APPLY TO YOU.

LIMITATION OF LIABILITY

IT IS UNDERSTOOD AND AGREED THAT BOXLIGHT'S LIABILITY WHETHER IN CONTRACT, IN TORT, UNDER ANY WARRANTY, IN NEGLIGENCE OR OTHERWISE SHALL NOT EXCEED THE RETURN OF THE AMOUNT OF THE PURCHASE PRICE PAID BY PURCHASER AND UNDER NO CIRCUMSTANCES SHALL BOXLIGHT BE LIABLE FOR SPECIAL, INDIRECT, INCIDENTAL OR CONSEQUENTIAL DAMAGES OR LOST PROFITS, LOST REVENUES OR LOST SAVINGS. THE PRICE STATED FOR THE PRODUCT IS A CONSIDERATION IN LIMITING BOXLIGHT'S LIABILITY. NO ACTION, REGARDLESS OF FORM, ARISING OUT OF THE AGREEMENT TO PURCHASE THE PRODUCT MAY BE BROUGHT BY PURCHASER MORE THAN ONE YEAR AFTER THE CAUSE OF ACTION HAS ACCRUED. SOME STATES DO NOT ALLOW THE EXCLUSION OR LIMITATION OF INCIDENTAL OR CONSEQUENTIAL DAMAGES SO THE ABOVE LIMITATION OR EXCLUSION MAY NOT APPLY TO YOU. THIS LIMITED WARRANTY GIVES YOU SPECIFIC LEGAL RIGHTS, AND YOU MAY ALSO HAVE OTHER RIGHTS WHICH VARY FROM STATE TO STATE.